

# **USER MANUAL** **(English)**

Solar Charger/Energizer

# **LFX 280**

Tel:+86 0510-85450099

Email: [lyditefencing@163.com](mailto:lyditefencing@163.com)

Website:[www.lyditefence.com](http://www.lyditefence.com)

Address:No.990 Jianghai West Road, Wuxi, Jiangsu, China.



# **CONTENTS**

Abstract introduction .....	1
Specification .....	1
Fitting .....	3
Accessories .....	4
Installation .....	7
Safety&Maintenance .....	10

## Abstract introduction

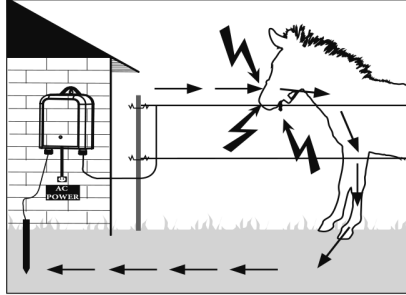

The energiser may be used outdoors only in conjunction with an electric fence to keep animals in/out as required.

The animal receives a shock when it completes the circuit between the fence and ground.

The fence consists of current-carrying wires and requires conductive (wet) soils.

For poorly conductive soil or wild animals several fence lines are used.

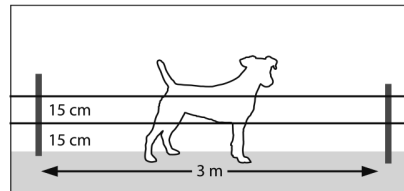
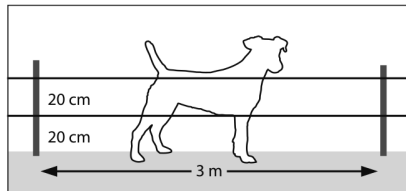
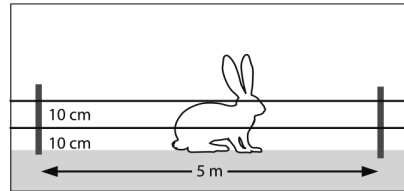
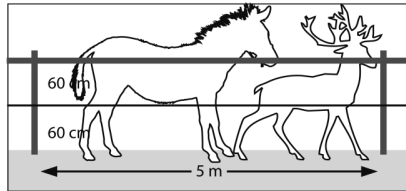
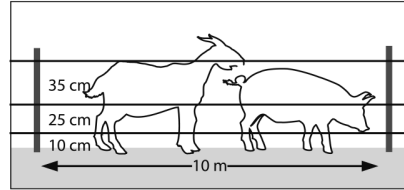
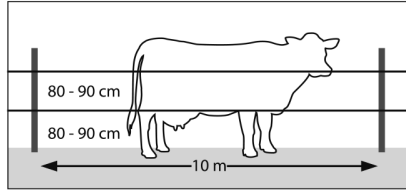

## Abstract introduction



**Power supply:** 12 volts/25w solar panel

**Consumption:** 0.11A~0.25A/ hour

**Voltage Vacuum:** 12000 volts

**Delivered power vacuum:** 3 joules

**Power output at 500 ohms:** 0.3~1.6 joules

**Effective length:** 30 km

**Plastic case. Dimensions:** 330\*240\*430 mm

**Weight:** 5 kg



### Fittings

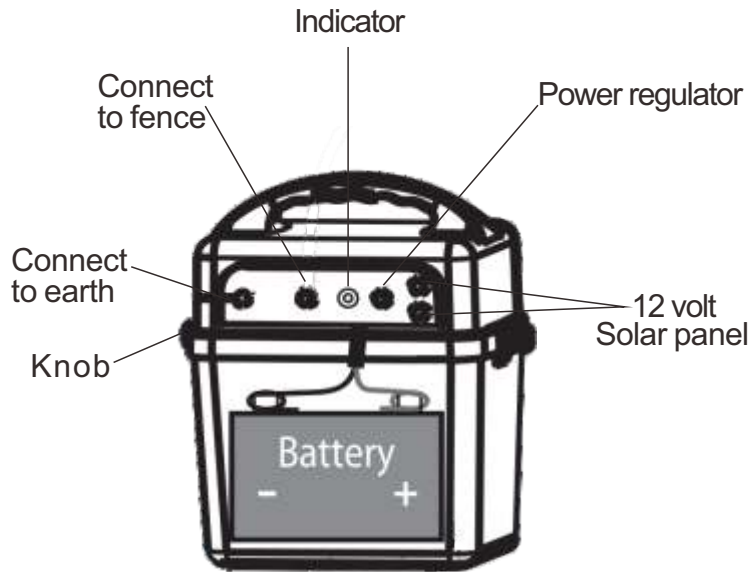

### Accessories



**Product name:** Solar Panel Brace

**Material:** Aluminum

**Weight:** 56.4g

**Use:** With energizer to support solar panel

**Description:** The upper two small holes are connected to the solar panel, and the lower small holes are connected to the energizer

## Abstract introduction



**Product Name:**Solar Panel  
**Power supply:**12v/25w  
**Size:**540\*350\*25mm  
**Weight:**1.9kg  
**Type:**Polycrystalline

## Abstract introduction



**Product Name:**Lead-acid battery  
**Volt:**12v  
**Consumption:**75ah  
**Size:**211\*260\*168mm  
**Weight:**21kg

# Installation

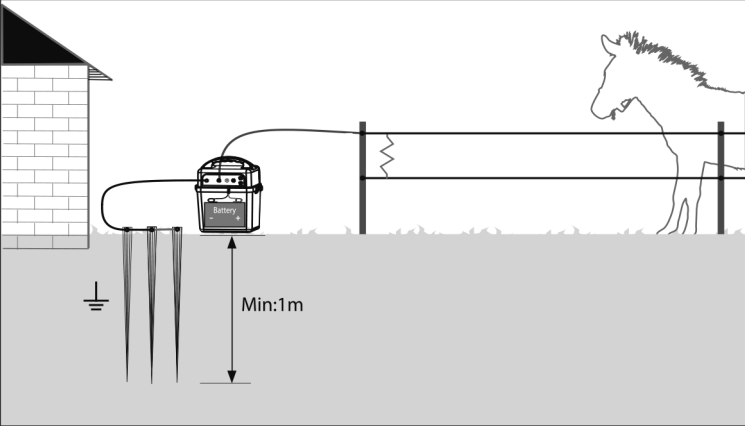
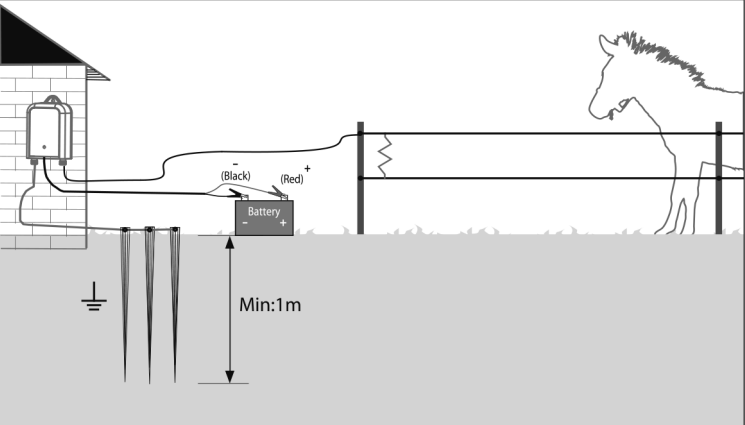

# Installation

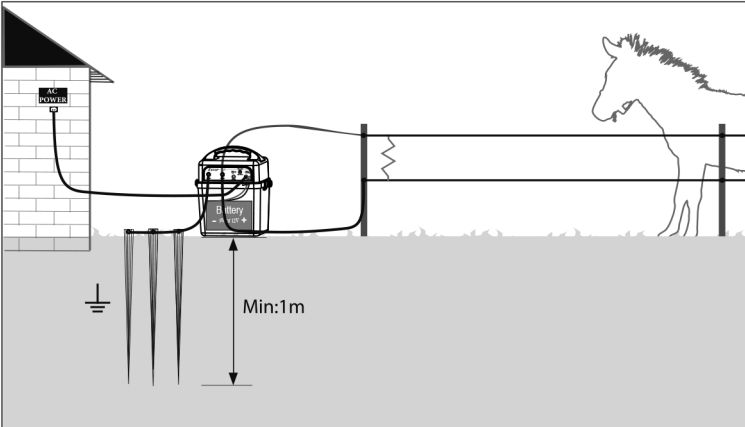
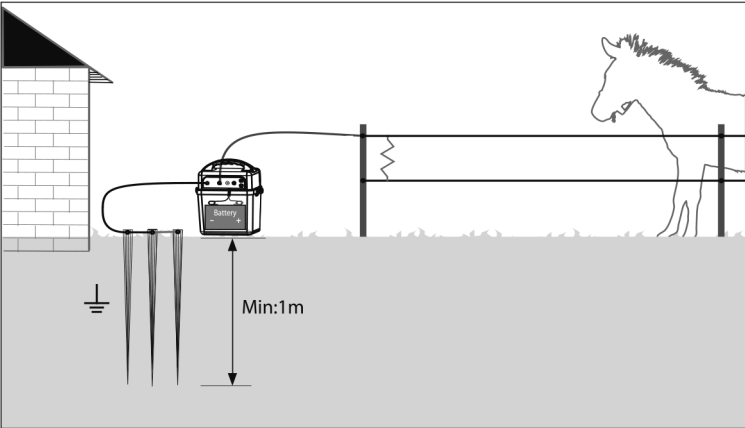

## Installation

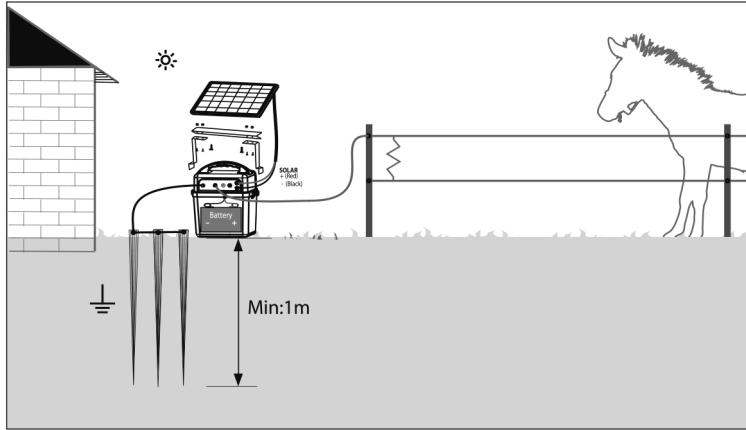

## Safety & Maintenance

### SAFETY

 Please read the instructions carefully before operating.

Behave in a responsible manner and treat an electric energiser with respect. The safety of those around must be taken into consideration, as the operator is responsible for any accident or danger to third parties.

Never Use electric fencing where it is likely to be touched by children or infants.

Where small children are likely to access a fence, the duty care requires some form of obstacle such as a one meter high chainlink or agricultural mesh fence.

### MAINTENANCE

Before performing any maintenance, disconnect the device from the power source

Equipment and fence line should be inspected regularly to ensure correct functioning.

Use a voltage tester to check the fence line everyday. This will highlight potential before the animals find them.

 Never dispose of household waste! Batteries must be brought to your nearest recycling center.



### Battery protection

To ensure the battery remains in good condition, the unit will automatically turn off once the battery is flat. The unit will restart once the battery has been recharged or replaced.

### Battery charging

#### Warning!

- Do not attempt to recharge a non-rechargeable battery.
- When recharging a battery, ensure that there is adequate ventilation to allow gases to disperse.

Regular recharging of the battery is essential. Use a suitably rated battery charger and refer to the battery manufacturer's recommendations.



### Solar Maintenance

- Check whether the battery board connection wire and the ground wire are in good contact, and whether there is any substitution phenomenon.
- Check whether there is heat at the junction of the junction box.
- Check whether the battery board bracket is loose or broken.
- Check and clean the weeds that cover the battery board around the battery board.
- Check if there is any covering on the surface of the battery board.